



ADCLK950

FEATURES

- 2 selectable differential inputs
- 4.8 GHz operating frequency
- 75 fs rms broadband random jitter
- On-chip input terminations
- 3.3 V power supply

APPLICATIONS

- Low jitter clock distribution
- Clock and data signal restoration
- Level translation
- Wireless communications
- Wired communications
- Medical and industrial imaging
- ATE and high performance instrumentation

GENERAL DESCRIPTION

The ADCLK950 is an ultrafast clock fanout buffer fabricated on the Analog Devices, Inc., proprietary XFCB3 silicon germanium (SiGe) bipolar process. This device is designed for high speed applications requiring low jitter.

The device has two selectable differential inputs via the IN_SEL control pin. Both inputs are equipped with center tapped, differential, 100 Ω on-chip termination resistors. The inputs accept dc-coupled LVPECL, CML, 3.3 V CMOS (single-ended), and ac-coupled 1.8 V CMOS, LVDS, and LVPECL inputs. A V_{REFX} pin is available for biasing ac-coupled inputs.

The ADCLK950 features 10 full-swing emitter coupled logic (ECL) output drivers. For LVPECL (positive ECL) operation, bias V_{CC} to the positive supply and V_{EE} to ground. For ECL operation, bias V_{CC} to ground and V_{EE} to the negative supply.

The output stages are designed to directly drive 800 mV each side into 50 Ω terminated to V_{CC} - 2 V for a total differential output swing of 1.6 V.

The ADCLK950 is available in a 40-lead LFCSP and specified for operation over the standard industrial temperature range of -40°C to +85°C.

FUNCTIONAL BLOCK DIAGRAM

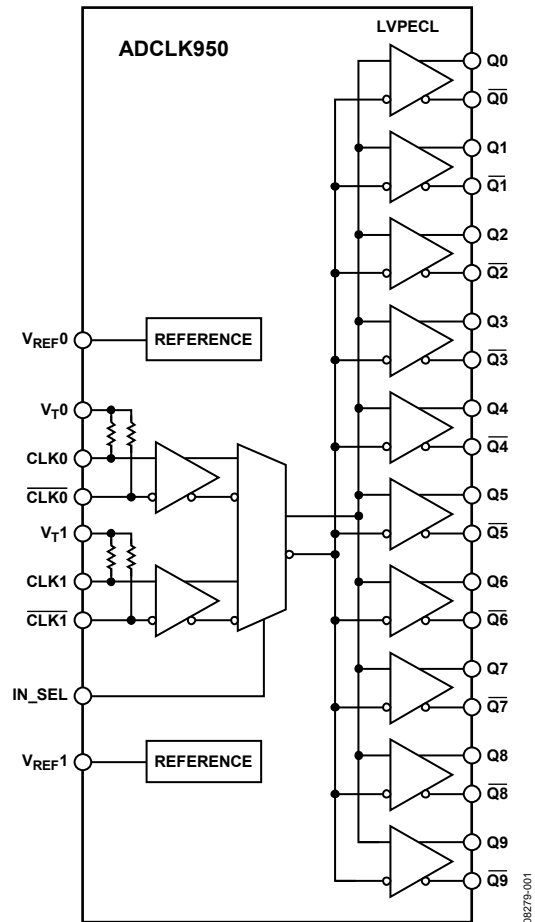

Figure 1.

08279-001

Rev. 0

Information furnished by Analog Devices is believed to be accurate and reliable. However, no responsibility is assumed by Analog Devices for its use, nor for any infringements of patents or other rights of third parties that may result from its use. Specifications subject to change without notice. No license is granted by implication or otherwise under any patent or patent rights of Analog Devices. Trademarks and registered trademarks are the property of their respective owners.

TABLE OF CONTENTS

Features	1	Pin Configuration and Function Descriptions.....	6
Applications.....	1	Typical Performance Characteristics	7
General Description	1	Functional Description.....	9
Functional Block Diagram	1	Clock Inputs	9
Revision History	2	Clock Outputs.....	9
Specifications.....	3	Clock Input Select (IN_SEL) Settings.....	10
Electrical Characteristics	3	PCB Layout Considerations.....	10
Absolute Maximum Ratings.....	5	Input Termination Options.....	11
Determining Junction Temperature	5	Outline Dimensions	12
ESD Caution.....	5	Ordering Guide	12
Thermal Performance.....	5		

REVISION HISTORY

7/09—Revision 0: Initial Version

SPECIFICATIONS

ELECTRICAL CHARACTERISTICS

Typical (Typ column) values are given for $V_{CC} - V_{EE} = 3.3\text{ V}$ and $T_A = 25^\circ\text{C}$, unless otherwise noted. Minimum (Min column) and maximum (Max column) values are given over the full $V_{CC} - V_{EE} = 3.3\text{ V} \pm 10\%$ and $T_A = -40^\circ\text{C}$ to $+85^\circ\text{C}$ variation, unless otherwise noted.

Table 1. Clock Inputs and Outputs

Parameter	Symbol	Min	Typ	Max	Unit	Test Conditions/Comments
DC INPUT CHARACTERISTICS						
Input Common Mode Voltage	V_{ICM}	$V_{EE} + 1.5$		$V_{CC} - 0.1$	V	$\pm 1.7\text{ V}$ between input pins
Input Differential Range	V_{ID}	0.4		3.4	V p-p	
Input Capacitance	C_{IN}		0.4		pF	
Input Resistance						Open V_{IX}
Single-Ended Mode			50		Ω	
Differential Mode			100		Ω	
Common Mode			50		k Ω	
Input Bias Current			20		μA	
Hysteresis			10		mV	
DC OUTPUT CHARACTERISTICS						
Output Voltage High Level	V_{OH}	$V_{CC} - 1.26$		$V_{CC} - 0.76$	V	$50\ \Omega$ to $(V_{CC} - 2.0\text{ V})$
Output Voltage Low Level	V_{OL}	$V_{CC} - 1.99$		$V_{CC} - 1.54$	V	$50\ \Omega$ to $(V_{CC} - 2.0\text{ V})$
Output Voltage Differential	V_{OD}	610		960	mV	$50\ \Omega$ to $(V_{CC} - 2.0\text{ V})$
Reference Voltage	V_{REF}					
Output Voltage			$(V_{CC} + 1)/2$		V	$-500\ \mu\text{A}$ to $+500\ \mu\text{A}$
Output Resistance			235		Ω	

Table 2. Timing Characteristics

Parameter	Symbol	Min	Typ	Max	Unit	Test Conditions/Comments
AC PERFORMANCE						
Maximum Output Frequency		4.5	4.8		GHz	See Figure 4 for differential output voltage vs. frequency, $>0.8\text{ V}$ differential output swing
Output Rise Time	t_R	40	75	90	ps	20% to 80% measured differentially
Output Fall Time	t_F	40	75	90	ps	
Propagation Delay	t_{PD}	175	210	245	ps	$V_{ICM} = 2\text{ V}$, $V_{ID} = 1.6\text{ V p-p}$
Temperature Coefficient			50		fs/ $^\circ\text{C}$	
Output-to-Output Skew ¹			9	28	ps	$V_{ID} = 1.6\text{ V p-p}$
Part-to-Part Skew				45	ps	
Additive Time Jitter						BW = 12 kHz – 20 MHz, CLK = 1 GHz $V_{ID} = 1.6\text{ V p-p}$, 8 V/ns, $V_{ICM} = 2\text{ V}$
Integrated Random Jitter			28		fs rms	
Broadband Random Jitter ²			75		fs rms	
Crosstalk-Induced Jitter ³			90		fs rms	
CLOCK OUTPUT PHASE NOISE						
Absolute Phase Noise						Input slew rate $> 1\text{ V/ns}$ (see Figure 11, the phase noise plot, for more details)
$f_{IN} = 1\text{ GHz}$			-119		dBc/Hz	@100 Hz offset
			-134		dBc/Hz	@1 kHz offset
			-145		dBc/Hz	@10 kHz offset
			-150		dBc/Hz	@100 kHz offset
			-150		dBc/Hz	$> 1\text{ MHz}$ offset

¹ The output skew is the difference between any two similar delay paths while operating at the same voltage and temperature.

² Measured at the rising edge of the clock signal; calculated using the SNR of the ADC method.

³ This is the amount of added jitter measured at the output while two related, asynchronous, differential frequencies are applied to the inputs.

ADCLK950

Table 3. Input Select Control Pin

Parameter	Symbol	Min	Typ	Max	Unit
Logic 1 Voltage	V_{IH}	$V_{CC} - 0.4$		V_{CC}	V
Logic 0 Voltage	V_{IL}	V_{EE}		1	V
Logic 1 Current	I_{IH}			100	μA
Logic 0 Current	I_{IL}			0.6	mA
Capacitance			2		pF

Table 4. Power

Parameter	Symbol	Min	Typ	Max	Unit	Test Conditions/Comments
POWER SUPPLY						
Supply Voltage Requirement	$V_{CC} - V_{EE}$	2.97		3.63	V	$3.3 V + 10\%$
Power Supply Current						Static
Negative Supply Current	I_{VEE}		106	130	mA	$V_{CC} - V_{EE} = 3.3 V \pm 10\%$
Positive Supply Current	I_{VCC}		346	390	mA	$V_{CC} - V_{EE} = 3.3 V \pm 10\%$
Power Supply Rejection ¹	PSR_{VCC}		<3		ps/V	$V_{CC} - V_{EE} = 3.3 V \pm 10\%$
Output Swing Supply Rejection ²	PSR_{VCC}		28		dB	$V_{CC} - V_{EE} = 3.3 V \pm 10\%$

¹ Change in t_{PD} per change in V_{CC} .

² Change in output swing per change in V_{CC} .

ABSOLUTE MAXIMUM RATINGS

Table 5.

Parameter	Rating
Supply Voltage $V_{CC} - V_{EE}$	6 V
Input Voltage CLK0, CLK1, $\overline{\text{CLK0}}$, $\overline{\text{CLK1}}$, IN_SEL	$V_{EE} - 0.5 \text{ V}$ to $V_{CC} + 0.5 \text{ V}$
CLK0, CLK1, $\overline{\text{CLK0}}$, $\overline{\text{CLK1}}$ to V_{TX} Pin (CML, LVPECL Termination)	$\pm 40 \text{ mA}$
CLK0, CLK1 to $\overline{\text{CLK0}}$, $\overline{\text{CLK1}}$	$\pm 1.8 \text{ V}$
Input Termination, V_{TX} to CLK0, CLK1, $\overline{\text{CLK0}}$, and $\overline{\text{CLK1}}$	$\pm 2 \text{ V}$
Maximum Voltage on Output Pins	$V_{CC} + 0.5 \text{ V}$
Maximum Output Current	35 mA
Voltage Reference (V_{REFX})	V_{CC} to V_{EE}
Operating Temperature Range	
Ambient	-40°C to $+85^{\circ}\text{C}$
Junction	150°C
Storage Temperature Range	-65°C to $+150^{\circ}\text{C}$

Stresses above those listed under Absolute Maximum Ratings may cause permanent damage to the device. This is a stress rating only; functional operation of the device at these or any other conditions above those indicated in the operational section of this specification is not implied. Exposure to absolute maximum rating conditions for extended periods may affect device reliability.

THERMAL PERFORMANCE

Table 6.

Parameter	Symbol	Description	Value ¹	Unit
Junction-to-Ambient Thermal Resistance	θ_{JA}			
Still Air		Per JEDEC JESD51-2	46.1	$^{\circ}\text{C}/\text{W}$
0 m/sec Air Flow				
Moving Air	θ_{JMA}	Per JEDEC JESD51-6	40.3	$^{\circ}\text{C}/\text{W}$
1 m/sec Air Flow			36.2	$^{\circ}\text{C}/\text{W}$
2.5 m/sec Air Flow				
Junction-to-Board Thermal Resistance	θ_{JB}			
Moving Air		Per JEDEC JESD51-8	28.7	$^{\circ}\text{C}/\text{W}$
1 m/sec Air Flow				
Junction-to-Case Thermal Resistance	θ_{JC}			
Moving Air		Per MIL-STD 883, Method 1012.1	8.3	$^{\circ}\text{C}/\text{W}$
Die-to-Heatsink				
Junction-to-Top-of-Package Characterization Parameter	Ψ_{JT}			
Still Air		Per JEDEC JESD51-2	0.6	$^{\circ}\text{C}/\text{W}$
0 m/sec Air Flow				

¹ Results are from simulations. The PCB is a JEDEC multilayer type. Thermal performance for actual applications requires careful inspection of the conditions in the application to determine if they are similar to those assumed in these calculations.

DETERMINING JUNCTION TEMPERATURE

To determine the junction temperature on the application printed circuit board (PCB), use the following equation:

$$T_J = T_{CASE} + (\Psi_{JT} \times P_D)$$

where:

T_J is the junction temperature ($^{\circ}\text{C}$).

T_{CASE} is the case temperature ($^{\circ}\text{C}$) measured by the customer at the top center of the package.

Ψ_{JT} is from Table 6.

P_D is the power dissipation.

Values of θ_{JA} are provided for package comparison and PCB design considerations. θ_{JA} can be used for a first-order approximation of T_J by the equation

$$T_J = T_A + (\theta_{JA} \times P_D)$$

where T_A is the ambient temperature ($^{\circ}\text{C}$).

Values of θ_{JB} are provided in Table 6 for package comparison and PCB design considerations.

ESD CAUTION



ESD (electrostatic discharge) sensitive device. Charged devices and circuit boards can discharge without detection. Although this product features patented or proprietary protection circuitry, damage may occur on devices subjected to high energy ESD. Therefore, proper ESD precautions should be taken to avoid performance degradation or loss of functionality.

ADCLK950

PIN CONFIGURATION AND FUNCTION DESCRIPTIONS

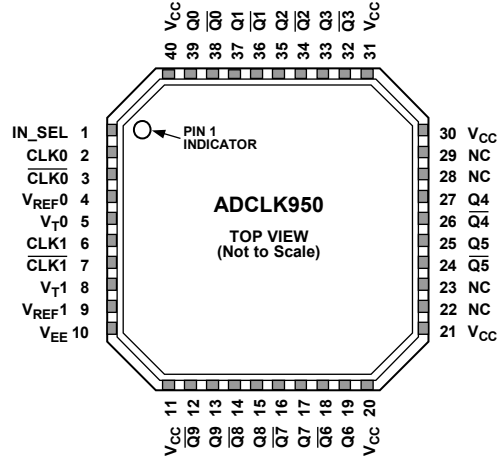

NOTES
 1. NC = NO CONNECT.
 2. EPAD MUST BE SOLDERED TO V_{EE} POWER PLANE.

08279-002

Figure 2. Pin Configuration

Table 7. Pin Function Descriptions

Pin No.	Mnemonic	Description
1	IN_SEL	Input Select. Logic 0 selects CLK0 and $\overline{\text{CLK0}}$ inputs. Logic 1 selects CLK1 and $\overline{\text{CLK1}}$ inputs.
2	CLK0	Differential Input (Positive) 0.
3	$\overline{\text{CLK0}}$	Differential Input (Negative) 0.
4	V _{REF0}	Reference Voltage. Reference voltage for biasing ac-coupled CLK0 and $\overline{\text{CLK0}}$ inputs.
5	V _{T0}	Center Tap. Center tap of a 100 Ω input resistor for CLK0 and $\overline{\text{CLK0}}$ inputs.
6	CLK1	Differential Input (Positive) 1.
7	$\overline{\text{CLK1}}$	Differential Input (Negative) 1.
8	V _{T1}	Center Tap. Center tap of a 100 Ω input resistor for CLK1 and $\overline{\text{CLK1}}$ inputs.
9	V _{REF1}	Reference Voltage. Reference voltage for biasing ac-coupled CLK1 and $\overline{\text{CLK1}}$ inputs.
10	V _{EE}	Negative Supply Pin.
11, 20, 21, 30, 31, 40	V _{CC}	Positive Supply Pin.
12, 13	$\overline{\text{Q9}}$, Q9	Differential LVPECL Outputs.
14, 15	$\overline{\text{Q8}}$, Q8	Differential LVPECL Outputs.
16, 17	$\overline{\text{Q7}}$, Q7	Differential LVPECL Outputs.
18, 19	$\overline{\text{Q6}}$, Q6	Differential LVPECL Outputs.
22, 23, 28, 29	NC	No Connection
24, 25	$\overline{\text{Q5}}$, Q5	Differential LVPECL Outputs.
26, 27	$\overline{\text{Q4}}$, Q4	Differential LVPECL Outputs.
32, 33	$\overline{\text{Q3}}$, Q3	Differential LVPECL Outputs.
34, 35	$\overline{\text{Q2}}$, Q2	Differential LVPECL Outputs.
36, 37	$\overline{\text{Q1}}$, Q1	Differential LVPECL Outputs.
38, 39	$\overline{\text{Q0}}$, Q0	Differential LVPECL Outputs.
(41)	EPAD	EPAD must be connected to V _{EE} .

TYPICAL PERFORMANCE CHARACTERISTICS

$V_{CC} = 3.3\text{ V}$, $V_{EE} = 0\text{ V}$, $V_{ICM} = V_{REFX}$, $T_A = 25^\circ\text{C}$, clock outputs terminated at $50\ \Omega$ to $V_{CC} - 2\text{ V}$, unless otherwise noted.

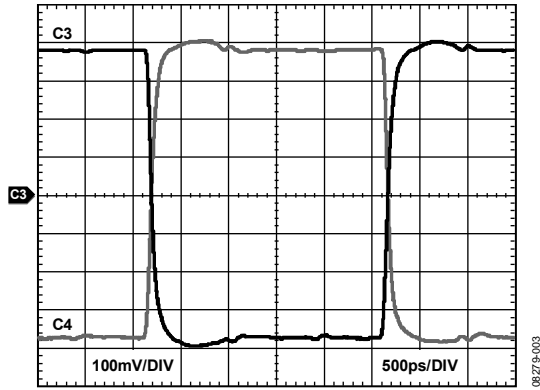

Figure 3. LVPECL Output Waveform @ 200 MHz

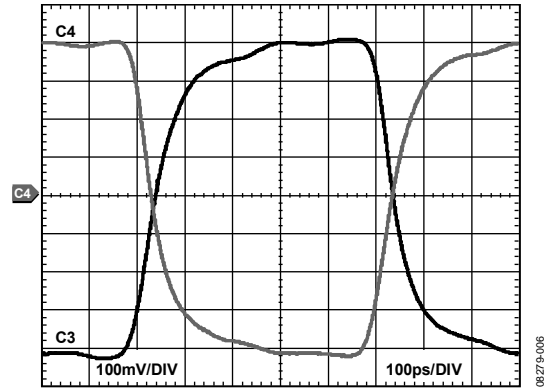

Figure 6. LVPECL Output Waveform @ 1000 MHz

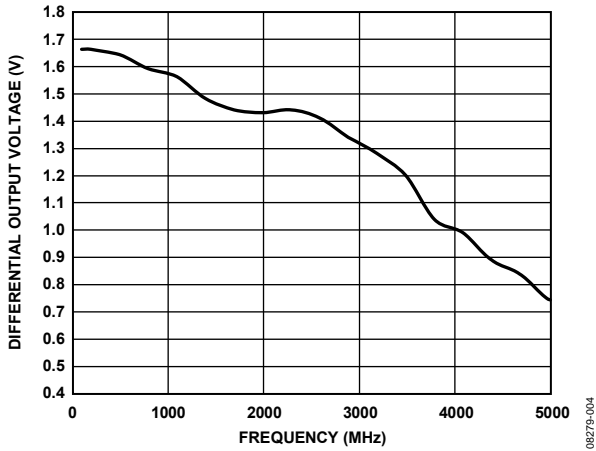

Figure 4. Differential Output Voltage vs. Frequency, $V_{ID} > 1.1\text{ V p-p}$

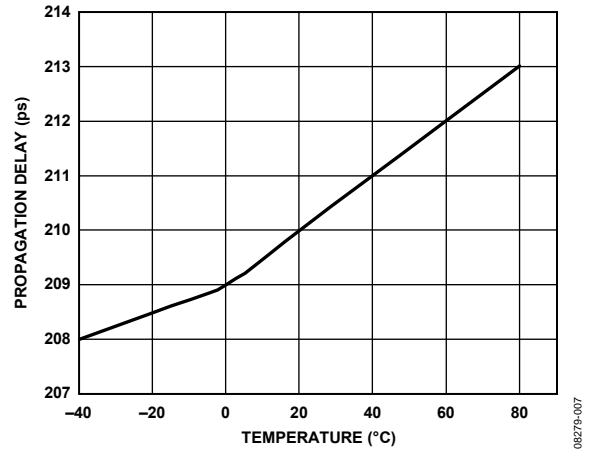

Figure 7. Propagation Delay vs. Temperature, $V_{ID} = 1.6\text{ V p-p}$

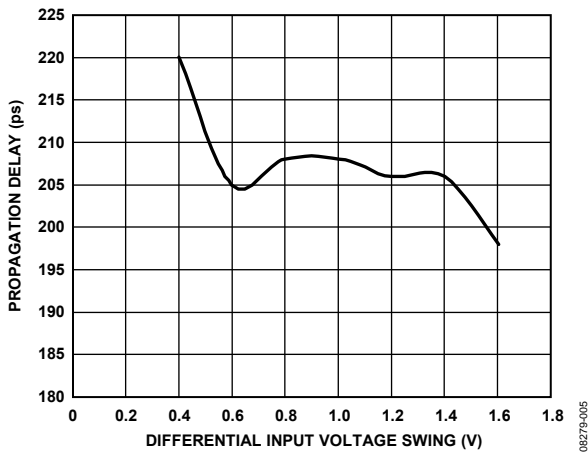

Figure 5. Propagation Delay vs. Differential Input Voltage

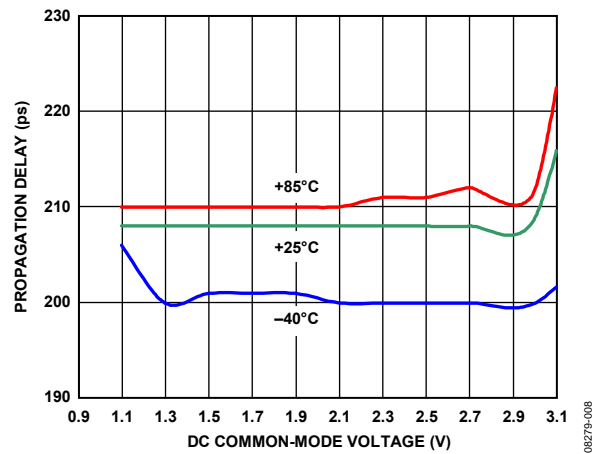

Figure 8. Propagation Delay vs. DC Common-Mode Voltage vs. Temperature, Input Slew Rate $> 25\text{ V/ns}$

ADCLK950

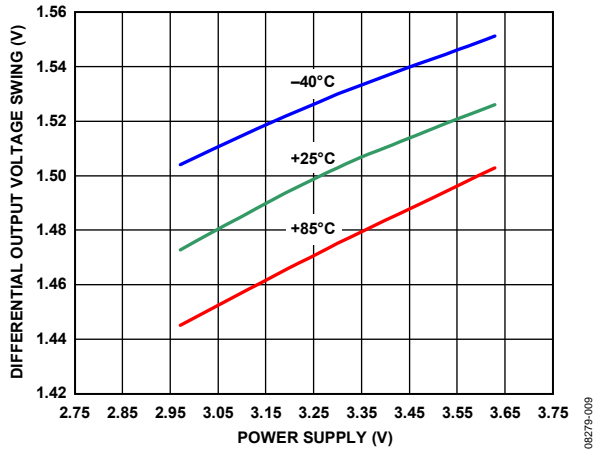

Figure 9. Differential Output Voltage Swing vs. Power Supply Voltage vs. Temperature, $V_{ID} = 1.6\text{ V p-p}$

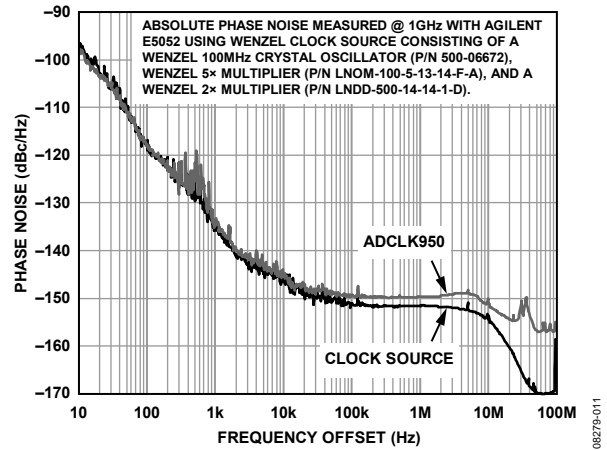

Figure 11. Absolute Phase Noise Measured @ 1 GHz

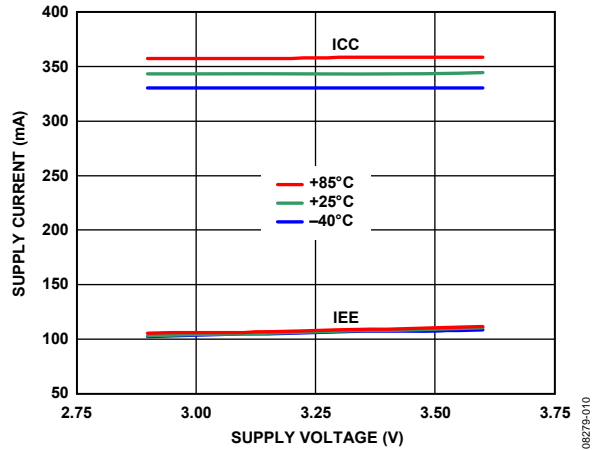

Figure 10. Power Supply Current vs. Power Supply Voltage vs. Temperature, All Outputs Loaded ($50\ \Omega$ to $V_{CC} - 2\text{ V}$)

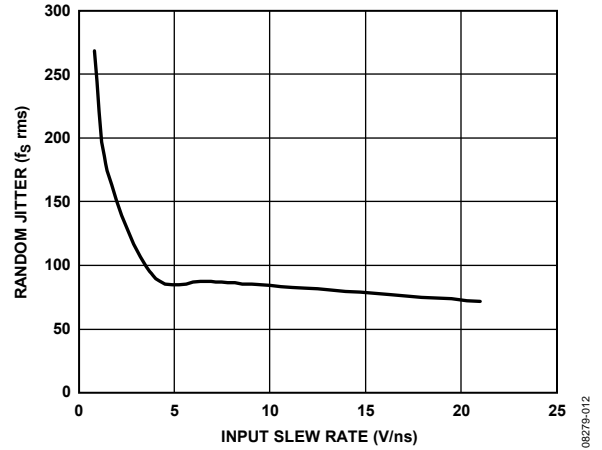

Figure 12. RMS Random Jitter vs. Input Slew Rate, V_{ID} Method

FUNCTIONAL DESCRIPTION

CLOCK INPUTS

The ADCLK950 accepts a differential clock input from one of two inputs and distributes the selected clock to all 10 LVPECL outputs. The maximum specified frequency is the point at which the output voltage swing is 50% of the standard LVPECL swing (see Figure 4). See the functional block diagram (Figure 1) and the General Description section for more clock input details. See Figure 19 through Figure 23 for various clock input termination schemes.

Output jitter performance is degraded by an input slew rate below 4 V/ns, as shown in Figure 12. The ADCLK950 is specifically designed to minimize added random jitter over a wide input slew rate range. Whenever possible, clamp excessively large input signals with fast Schottky diodes because attenuators reduce the slew rate. Input signal runs of more than a few centimeters should be over low loss dielectrics or cables with good high frequency characteristics.

CLOCK OUTPUTS

The specified performance necessitates using proper transmission line terminations. The LVPECL outputs of the ADCLK950 are designed to directly drive 800 mV into a 50 Ω cable or into microstrip/stripline transmission lines terminated with 50 Ω referenced to $V_{CC} - 2V$, as shown in Figure 14. The LVPECL output stage is shown in Figure 13. The outputs are designed for best transmission line matching. If high speed signals must be routed more than a centimeter, either the microstrip or the stripline technique is required to ensure proper transition times and to prevent excessive output ringing and pulse width dependent propagation delay dispersion.

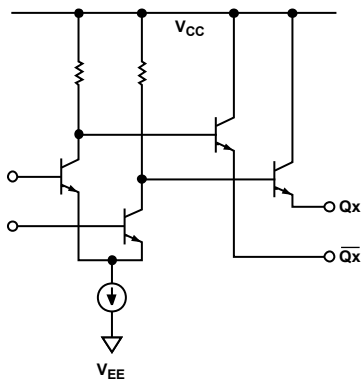

Figure 13. Simplified Schematic Diagram of the LVPECL Output Stage

Figure 14 through Figure 17 depict various LVPECL output termination schemes. When dc-coupled, V_s of the receiving buffer should match V_{S_DRV} .

Thevenin-equivalent termination uses a resistor network to provide 50 Ω termination to a dc voltage that is below V_{OL} of the LVPECL driver. In this case, V_{S_DRV} on the ADCLK950 should equal V_s of the receiving buffer. Although the resistor combination shown (in Figure 15) results in a dc bias point of $V_{S_DRV} - 2V$, the actual common-mode voltage is $V_{S_DRV} - 1.3V$ because there is additional current flowing from the ADCLK950 LVPECL driver through the pull-down resistor.

LVPECL Y-termination is an elegant termination scheme that uses the fewest components and offers both odd- and even-mode impedance matching. Even-mode impedance matching is an important consideration for closely coupled transmission lines at high frequencies. Its main drawback is that it offers limited flexibility for varying the drive strength of the emitter follower LVPECL driver. This can be an important consideration when driving long trace lengths but is usually not an issue.

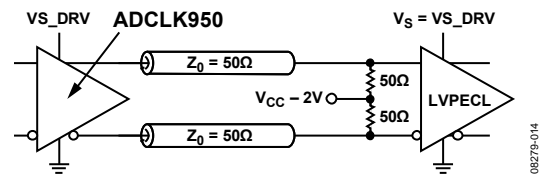

Figure 14. DC-Coupled, 3.3 V LVPECL

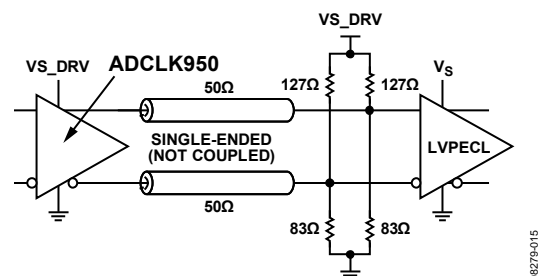

Figure 15. DC-Coupled, 3.3 V LVPECL Far-End Thevenin Termination

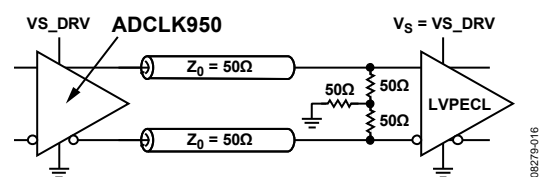

Figure 16. DC-Coupled, 3.3 V LVPECL Y-Termination

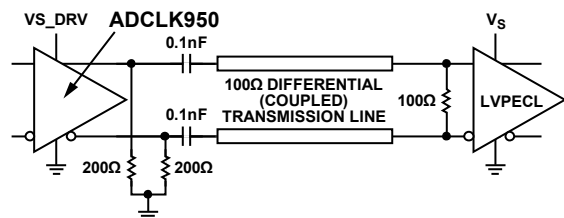

Figure 17. AC-Coupled, LVPECL with Parallel Transmission Line

ADCLK950

CLOCK INPUT SELECT (IN_SEL) SETTINGS

A Logic 0 on the IN_SEL pin selects the Input CLK0 and Input CLK0. A Logic 1 on the IN_SEL pin selects Input CLK1 and Input $\overline{\text{CLK1}}$.

PCB LAYOUT CONSIDERATIONS

The ADCLK950 buffer is designed for very high speed applications. Consequently, high speed design techniques must be used to achieve the specified performance. It is critically important to use low impedance supply planes for both the negative supply (V_{EE}) and the positive supply (V_{CC}) planes as part of a multilayer board. Providing the lowest inductance return path for switching currents ensures the best possible performance in the target application.

The following references to the GND plane assume that the V_{EE} power plane is grounded for LVPECL operation. Note that for ECL operation, the V_{CC} power plane becomes the ground plane.

It is also important to adequately bypass the input and output supplies. Place a 1 μF electrolytic bypass capacitor within several inches of each V_{CC} power supply pin to the GND plane. In addition, place multiple high quality 0.001 μF bypass capacitors as close as possible to each of the V_{CC} supply pins, and connect the capacitors to the GND plane with redundant vias. Carefully select high frequency bypass capacitors for minimum inductance and ESR. To improve the effectiveness of the bypass at high frequencies, minimize parasitic layout inductance. Also, avoid discontinuities along input and output transmission lines that can affect jitter performance.

In a 50 Ω environment, input and output matching have a significant impact on performance. The buffer provides internal 50 Ω termination resistors for both CLKx and $\overline{\text{CLKx}}$ inputs. Normally, the return side is connected to the reference pin that is provided. Carefully bypass the termination potential using ceramic capacitors to prevent undesired aberrations on the input signal due to parasitic inductance in the termination

return path. If the inputs are dc-coupled to a source, take care to ensure that the pins are within the rated input differential and common-mode ranges.

If the return is floated, the device exhibits a 100 Ω cross termination, but the source must then control the common-mode voltage and supply the input bias currents.

There are ESD/clamp diodes between the input pins to prevent the application from developing excessive offsets to the input transistors. ESD diodes are not optimized for best ac performance. When a clamp is required, it is recommended that appropriate external diodes be used.

Exposed Metal Paddle

The exposed metal paddle on the ADCLK950 package is both an electrical connection and a thermal enhancement. For the device to function properly, the paddle must be properly attached to the V_{EE} power plane.

When properly mounted, the ADCLK950 also dissipates heat through its exposed paddle. The PCB acts as a heat sink for the ADCLK950. The PCB attachment must provide a good thermal path to a larger heat dissipation area. This requires a grid of vias from the top layer down to the V_{EE} power plane (see Figure 18). The ADCLK950 evaluation board (ADCLK950/PCBZ) provides an example of how to attach the part to the PCB.

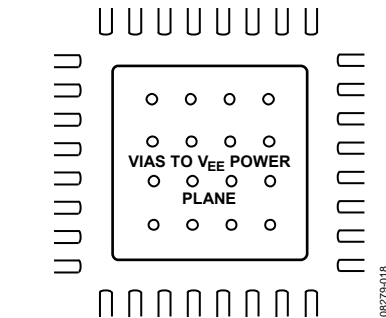
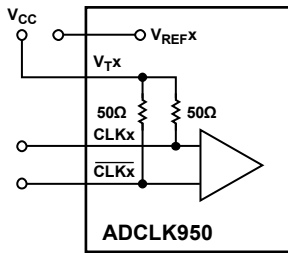

Figure 18. PCB Land for Attaching Exposed Paddle

INPUT TERMINATION OPTIONS



CONNECT V_{Tx} TO V_{CC} .

08279-019

Figure 19. DC-Coupled CML Input Termination

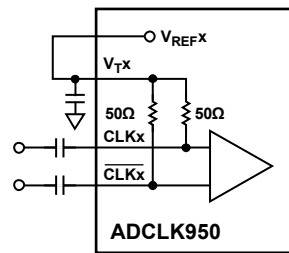

CONNECT V_{Tx} TO V_{REFx} .

08279-021

Figure 21. AC-Coupled Input Termination, Such as LVDS and LVPECL

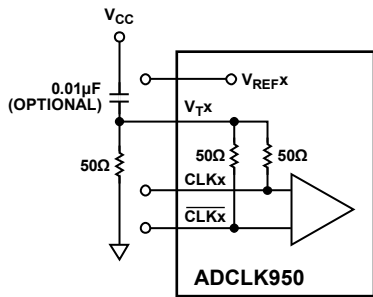
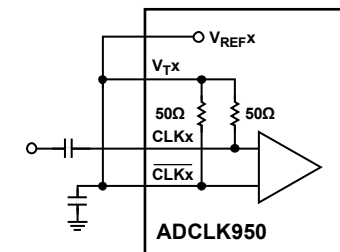

Figure 20. DC-Coupled LVPECL Input Termination

08279-020



CONNECT V_{Tx} , V_{REFx} , AND \overline{CLKx} . PLACE A BYPASS CAPACITOR FROM V_{Tx} TO GROUND. ALTERNATIVELY, V_{Tx} , V_{REFx} , AND $CLKx$ CAN BE CONNECTED, GIVING A CLEANER LAYOUT AND A 180° PHASE SHIFT.

08279-022

Figure 22. AC-Coupled Single-Ended Input Termination

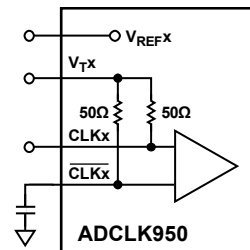
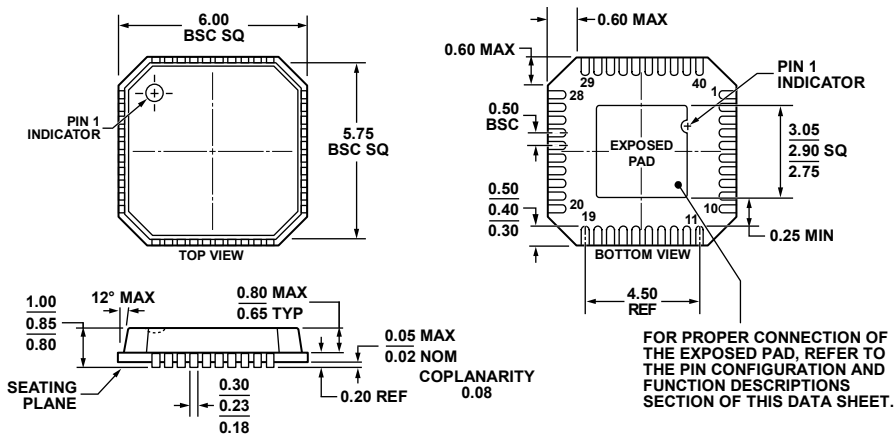

Figure 23. DC-Coupled 3.3 V CMOS Input Termination

08279-023

ADCLK950

OUTLINE DIMENSIONS



COMPLIANT TO JEDEC STANDARDS MO-220-VJJD-2
 Figure 24. 40-Lead Lead Frame Chip Scale Package [LFCSP_VQ]
 6 mm × 6 mm Body, Very Thin Quad
 (CP-40-8)
 Dimensions shown in millimeters

082708-A

ORDERING GUIDE

Model	Temperature Range	Package Description	Package Option
ADCLK950BCPZ ¹	-40°C to +85°C	40-Lead LFCSP_VQ	CP-40-8
ADCLK950BCPZ-REEL7 ¹	-40°C to +85°C	40-Lead LFCSP_VQ	CP-40-8
ADCLK950/PCBZ ¹		Evaluation Board	

¹ Z = RoHS Compliant Part.